

BAUER
COMPANY, INC.
HARDSCAPE PRODUCTS



H A R D S C A P E P R O D U C T S

TABLE OF CONTENTS

Table of Contents	2
Bauer Company - 100 Years	3
Bauer Product Listing and Descriptions	4-5
Bauer Product Photo Gallery	6-15
Keystone Garden Wall / Legacy Stone	16-17
Keystone Compac III	18-21
Keystone Verazzo Stone	22-23
Keystone Country Manor & Stonegate.	24-29
Colonial Wall	30-31
Hardscape Products	32-45
Outdoor Fireplaces	32-35
Fire Pit.	36-37
Integral® Lighting.	38
Colorfalls	39
Nicolock Paving Stones.	40-43
Hardscape Accessories and Tools	44-45
Installation.	46-47
Geo-Grid.	48-49
Do-It-Yourself.	50
Frequently Asked Questions	51
About The Bauer Company, Inc..	52
Warranty Information	53
Estimating	54

Although 100 years is a rare milestone for any business, the steps needed to reach it are simple. Taking good care of your employees, delivering the best products and service to our customers, and adjusting to changes in the marketplace.

At Bauer Company, our mission is to combine the highest quality products with an unmatched level of market and technical support. It is a goal that we continue to embrace as we look to the next 100 years.....



The Bauer Company Through The Years



The Bauer Company manufacturing facility in Kittanning, PA in 1992. This facility was in operation from 1922 to 2003.

The Bauer Company manufacturing facility in Indiana, PA nearing completion in 1977. This facility was in operation from 1977 to 2011.



Our current production facility located in Worthington, PA opened in 2002 and manufactures products for both the Hardscape and Construction Markets including Regular CMU, Split Face Units, Retaining Wall Block and Various Specialty Concrete Units.



BAUER PRODUCTS

Each project is unique in some way. Bauer's comprehensive product lines address various wall heights, site layouts, and architectural goals to ensure that you will have the right product for your specific project. Retaining walls enhance the landscape and add structural definition and lasting beauty to your home.

Bauer products can be used for a wide variety of applications from flower beds and borders, to large hills and slopes.

Keystone is the most trusted and recognized brand name in the retaining wall industry. From small planter walls to major commercial projects, Keystone's products offer the variety, features, and benefits for your specific needs.

Durability — All Keystone products manufactured by Bauer are made of non-corrosive, high compressive strength concrete, and have low water absorption meeting A.S.T.M. C1372 requirements for retaining walls, ensuring long term durability.

Ease of installation — Dry stacked units with pinned or lipped connections, do not require any mortar. This allows for fast installation.



COLONIAL WALL



Above & Below: COUNTRY MANOR
Left: COMPAC VICTORIAN



Cost effective — Mass production in our state-of-the-art facility ensures competitive costs while maintaining a high level of quality control.

Bauer's full line of products all have distinct features and benefits. Combined with their high strength, low absorption concrete, they provide permanent, environmentally safe walls that are virtually maintenance free, ensuring long term beauty and strength.

Keystone Garden Wall and Legacy Stone

Keystone's Garden Wall and Legacy Stone Systems are lightweight, easy to handle and have a natural look of quarried stone. Rear Lip Systems are appropriate for most retaining or terrace walls up to three-feet high. See pages 16-17 for additional details.

Keystone, Compac III and Verazzo Stone

Keystone's Pinned System units are appropriate for a variety of applications, including low height landscape walls, and taller structural walls which require reinforcement. See pages 18-23 for additional details.

Country Manor & Stonegate

Keystone's Country Manor and Stonegate walls evoke the Old World charm of a mason-crafted wall and are appropriate for free standing walls and retaining walls. See pages 24-29 for additional details.



COUNTRY
MANOR



KEYSTONE
Verazzo Stone™

COLONIAL WALL



Colonial Wall

Bauer's Colonial Wall is a light weight single size unit, that is ideal for small border or accent walls, but is ideally suited for creating outdoor kitchens, fireplaces, and columns. See pages 30-31 for additional details.

Nicolock Paving Stones

Nicolock's diverse product line adds style and function to your next project. As you create your dream landscape, a backyard patio, elegant driveway or private pathway through your garden. See page 40-43 for additional details.

Hardscape Products

Bauer carries a wide variety of accessory products that can be integrated into your projects. These include water features, accent lighting, specialty tools and cut stone to finish off your project. See page 32-45 for additional details.



COUNTRY MANOR



COLONIAL WALL



COMPAC Straight Face





Top: COLONIAL WALL
Bottom Left and Right: COMPAC VICTORIAN

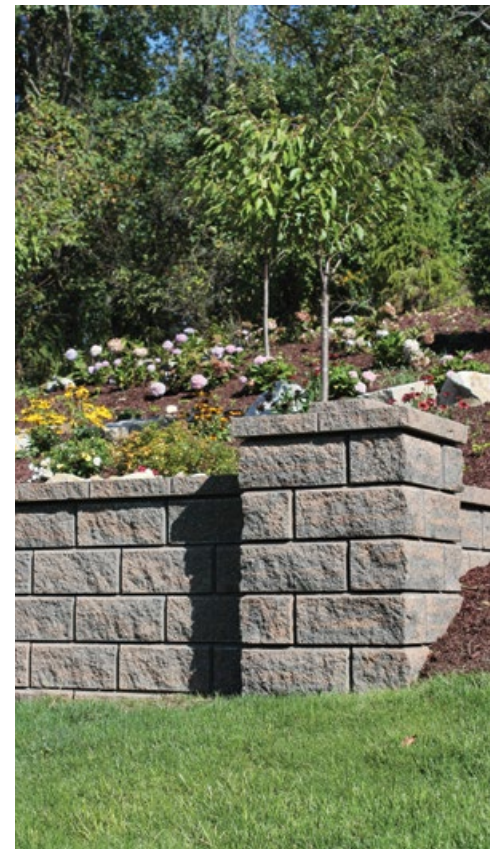



COUNTRY MANOR



COUNTRY MANOR



STONEGATE COUNTRY MANOR



COLONIAL WALL



STONEGATE COUNTRY MANOR and COLONIAL WALL



COMPAC Straight Face



LEGACY STONE Three Plane Face



COLONIAL WALL



COUNTRY MANOR



COLONIAL WALL with built-in grill station.



VERAZZO STONE



GARDEN WALL



COLONIAL WALL

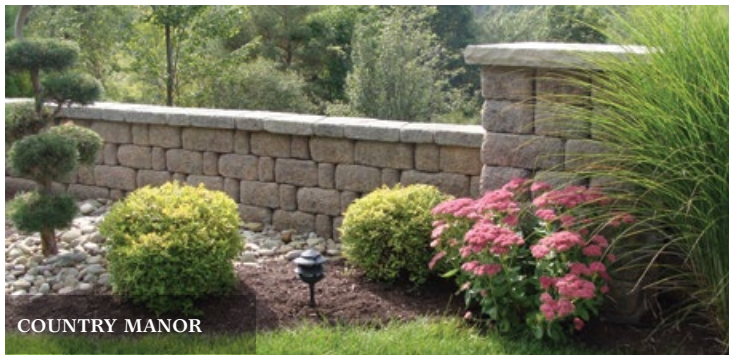

COUNTRY MANOR



COLONIAL WALL

BAUER

COMPANY, INC.

HARDSCAPE PRODUCTS



COLONIAL WALL custom outdoor bar, fence walls, and gate pillars.





COLONIAL WALL — Note: Custom fabricated steel plate is used to support the arch.



STONEGATE COUNTRY MANOR with VERAZZO STONE accent banding.

GARDEN WALL & LEGACY STONE

Keystone Rear Lip products are ideal for smaller residential walls, and can be used to create a raised bed for planting a flower garden. They create the perfect accent for tree rings, and with multiple colors and finishes, the lighter weight of these units make them ideal for homeowners to handle.

Keystone's Rear Lip products consist of the Legacy Stone and the Garden Wall. These units are lightweight and easy to handle, and they require no pins or mortar making them perfect for the homeowner to use on residential projects. The sculpted rock face provides for a natural appearance that subtly changes with the lighting of the day.

The Rear Lip System is available in two sizes—the Garden Wall and Legacy Stone, both are versatile for walls less than three-foot-high. The Garden Wall can be used for flower beds or tree rings and the Legacy Stone fits the contours of a yard to define property borders and edge a garden.



Top right: GARDEN WALL
Right: LEGACY STONE Straight Face

PRODUCT SPECIFICATIONS

*Garden Wall
Three Plane Face*



9" D, 4" H, 12" W
Weight: 28 lbs
*Total SFF x 3

*Legacy Stone
Three Plane Face*



10 3/8" D, 6" H, 16" W
Weight: 59 lbs
*Total SFF x 1.5

*Legacy Stone
Straight Face*



10 3/8" D, 6" H, 16" W
Weight: 61 lbs
*Total SFF x 1.5

Universal Cap Unit



12" D, 3" H, 16" W
Weight: 45 lbs
*Total Wall Length ÷ 1.33

Note: All Legacy Stone products may not be in stock at all times and may require additional production times of 2-3 weeks. Contact Bauer or your local Authorized Dealer for current availability.

***To estimate the amount of product needed for your wall, complete the Estimating section (page 54) and apply the calculations to the equation for the desired product. For example: 55 SFF x 3 = 165 Garden Wall Units needed.**

COLOR SAMPLE CHART



Brown

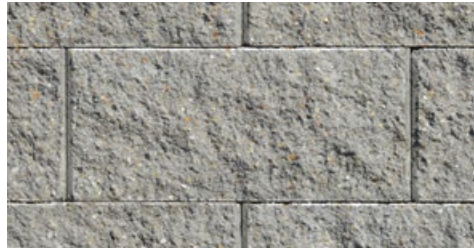

Gray



Golden Buff/Charcoal Blend



Charcoal



Red

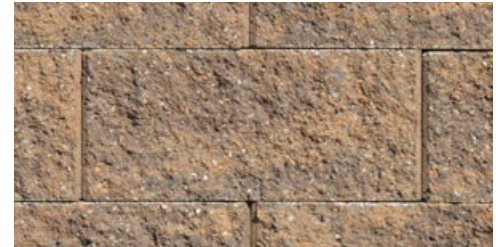

Sandstone/Brown Blend

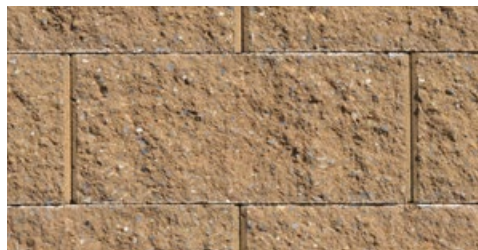

Sandstone

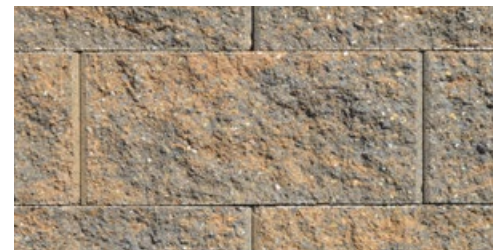

Sandstone/Charcoal Blend

Note: To assist in leveling, the rear lip on the bottom of a LEGACY STONE or GARDEN WALL unit may be removed for the first course.



Building Curves Into Your Wall

The interlocking lip on the Legacy Stone and Garden Wall products can easily accommodate curves while maintaining consistent setbacks. When building a tight convex curve, you can remove part of the outside edges of the lip with a hammer as needed to maintain the proper set-back angle. If building a concave curve, remove the middle of the lip to maintain proper set-back. If binding or gapping occurs, you may remove additional sections of the lip. Curves as small as 2'-2" in radius can be built with Garden Wall. Legacy Stone curves can be built with a radius as small as 3'-6". Minimum is at top of wall. Take into account the set-back on prior courses.

Setback Walls

Both the Garden Wall and Legacy Stone units can be designed to incorporate consistent setbacks.

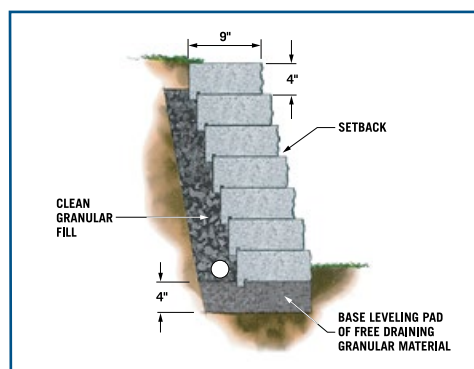
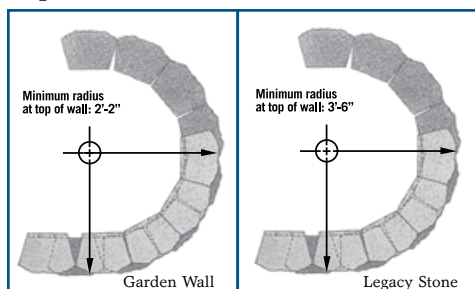

GARDEN WALL cross section

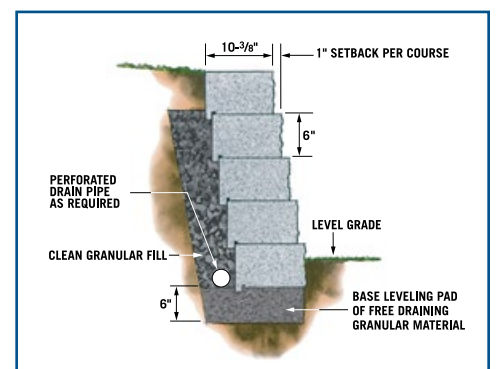

LEGACY STONE cross section



COMPAC III

A properly designed retaining wall will be a long-lasting and valuable addition to your property. The Keystone Pinned System combines strength and beauty for both gravity and reinforced walls.

The Keystone Compac III is the perfect choice and an installer's favorite. It also offers four distinct face finishes; Three Plane Split, Straight Face, Victorian, and Regency. (see page 20 for finishes).

The Pinned System is easy to install through a patented fiberglass connector pin providing additional shear strength. And because the Pinned System can be used with reinforcement, it is appropriate for tall walls, short walls, critical and non-critical structures.



COMPAC Straight Face



COMPAC Three Plane Face



COMPAC Three Plane Face

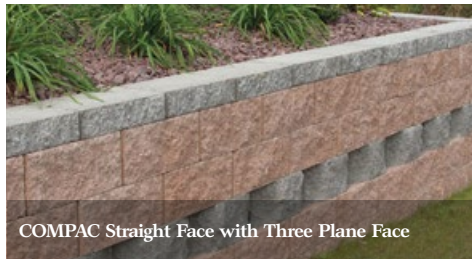

COMPAC Straight Face with Three Plane Face



COMPAC Three Plane Face



COMPAC Three Plane Face



COMPAC III

Pinned products can be used for all wall heights, but perform well when a project requires a structural wall to handle large changes in grade or to support loads like a driveway or steep slope. Most structural projects should be reviewed by a qualified engineer to ensure long term stability.

Compac III Victorian Stone features a unique chamfer around the outside edges. Ideally suited for both landscape and structural walls it's unique defined lines will make your project stand out creating a bold attractive appearance.

Compac III Regency & Regency Scored Units can be combined together to create the illusion of multiple size units within the wall face. The suggested ratio is 2/3 Regency and 1/3 Regency Scored units, however you can experiment to achieve the desired look you want. You can also use either unit by itself to create different looks. Regency has a hard split face and vertical chamfers with an antiqued finish.



COMPAC VICTORIAN



COMPAC REGENCY and REGENCY SCORE

PRODUCT SPECIFICATIONS

Compac III Three Plane Face

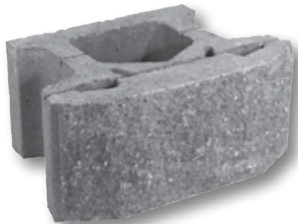

12" D, 8" H, 18" W
Weight: 74 lbs
*Total SFF x 1

Compac III Straight Face

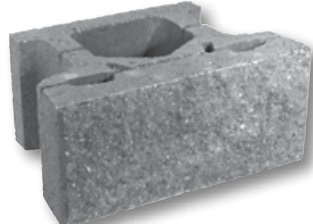

12" D, 8" H, 18" W
Weight: 78 lbs
*Total SFF x 1

Compac III Victorian



12" D, 8" H, 18" W
Weight: 77 lbs
*Total SFF x 1
Compac III unit is not compatible with the previous Compac unit.

*Victorian 8" Corner***
(Right corner pictured)



9" D, 8" H, 18" W
Weight: 115 lbs
*SFF area = 1.5
**Specify left or right unit when ordering Victorian.

Compac III Regency



12" D, 8" H, 18" W
Weight: 77 lbs
*Total SFF x 1

Compac III Regency Score



12" D, 8" H, 18" W
Weight: 77 lbs
*Total SFF x 1

Universal Cap Unit

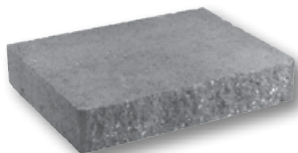

12" D, 3" H, 16" W
Weight: 45 lbs
*Total Wall Length ÷ 1.33

Mini Cap Unit

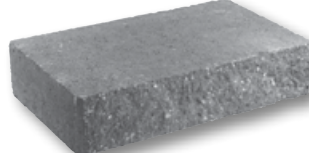

10 1/2" D, 4" H, 18" W
Weight: 55 lbs
*Total Wall Length ÷ 1.5

8" Corner



9" D, 8" H, 18" W
Weight: 115 lbs
*SFF area = 1.5

*To estimate the amount of product needed for your wall, complete the Estimating section (page 49) and apply the calculations to the equation for the desired product. For example: 55 SFF x 1 = 55 Compac III Units needed.

For installation of Geo-grid with pinned systems refer to Geo-grid Installation on pages 48-49.

COLOR SAMPLE CHART

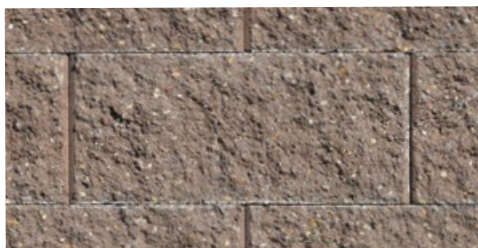

Brown

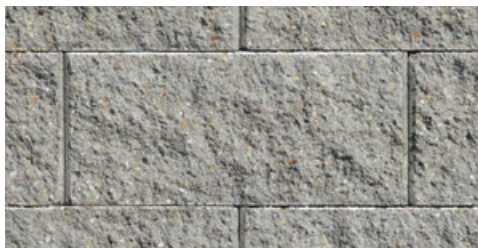

Gray

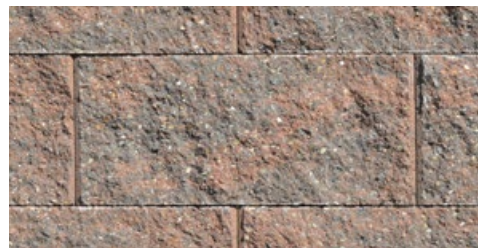

Golden Buff/Charcoal Blend



Charcoal

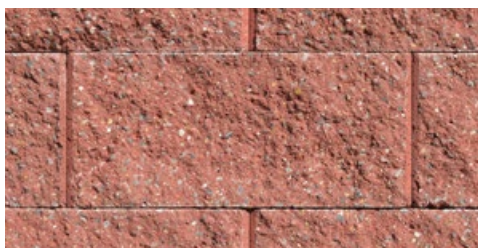

Red

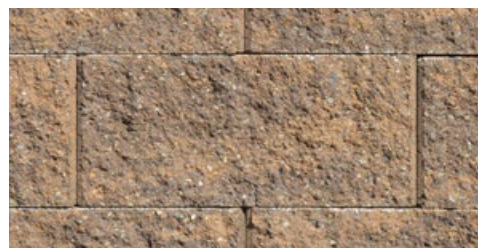

Sandstone/Brown Blend

Bauer's products are made in a wide variety of colors to complement any structure or landscape.

Hint: Instead of trying to match the color of your house choose a contrasting color, or stay with earth tones.

* Color not available in Mini Cap.

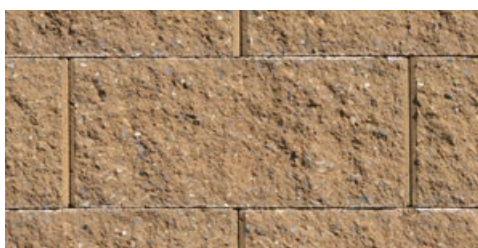

Sandstone

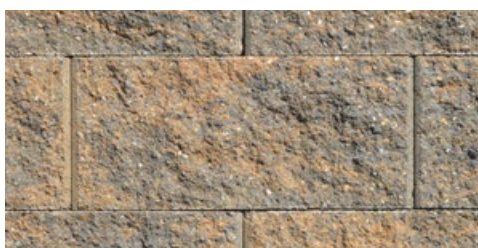

Sandstone/Charcoal Blend

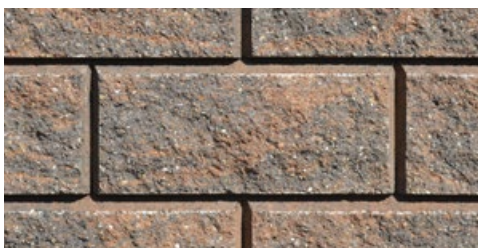

*Victorian Onyx/Toffee

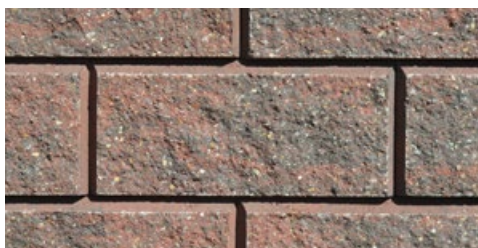

*Victorian Ruby/Onyx



*Regency Onyx/Toffee

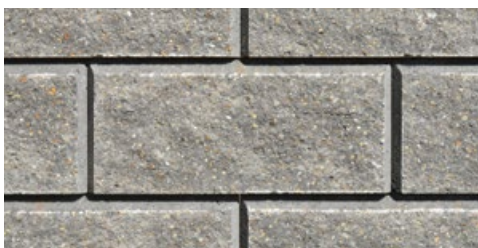

*Victorian Onyx/Natural

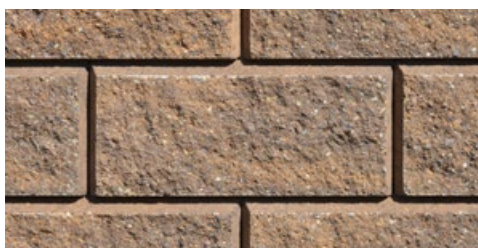

Victorian Sandstone/Brown



Regency Sandstone/Brown

Fiberglass Pins

Keystone's patented Pinned System features high-strength fiberglass pins that provide a shear connector, securely holding Geo-grid reinforcement and aligning units. Pins fit all size units (except Country Manor which uses a shouldered pin). Two pins are needed for each unit.



Pinned System Capping Options

Keystone Retaining Walls are not complete without caps. They are available in three and four-inch high units.

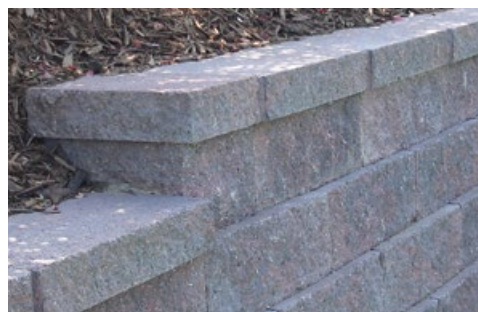
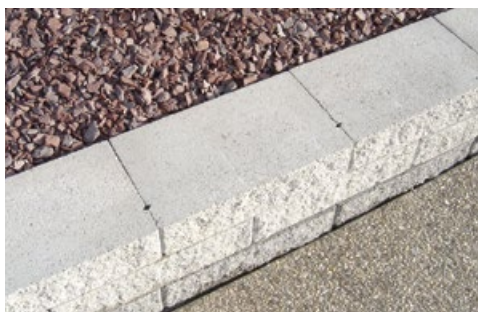

VERAZZO STONE™

Keystone Verazzo Stone™ adds another option for structural walls where a smaller unit profile is desired. The addition of a two sided unit, allows Verazzo Stone Double Split to be used for free standing walls, and raised patio walls to define outdoor living space.

When a structural wall is required, but the 8" profile of a Keystone Compac unit is too large, Verazzo Stone™ is just right with it's 6 inch height, it can be used for structural walls up to 10 feet high. Verazzo Stone™ comes in two styles either single split for traditional retaining use, or double split for free standing and parapet walls, or they can both be used together as they both use Keystone's proven pinned method for unmatched strength. As an alternative double split Verazzo Stone™ can be used in a retaining wall application with every other unit turned to create two unique sizes within the wall face.

Keystone Verazzo Stone™ is easy to install and allows for tight fitting straight walls and with it's tapered sides it also provides for graceful curves and radius walls. Each unit has multiple pin positions which allow either positive, vertical, or set-back options.



Right: VERAZZO STONE

PRODUCT SPECIFICATIONS

Verazzo Stone™
Single Split



12" D x 6" H x 16" W
Weight: 76 lbs
*Total SFF x 1.5

Verazzo Stone™
Double Split



10" D x 6" H x 16-12" W
Weight: 67 lbs
*See Note:

Verazzo Stone™
6" Corner Unit



8" D x 6" H x 16" W
Weight: 61 lbs
*Total SFF = 1

Verazzo Stone™
Double Split Cap Unit

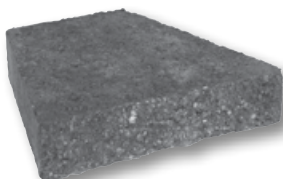

(Finished two sides)
12" D x 3" H x 14"- 8" W
Weight: 25 lbs

Universal Cap Unit

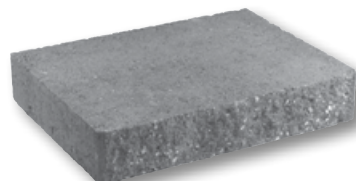

12" D, 3" H, 16" W
Weight: 45 lbs
*Total Wall Length ÷ 1.33

* To estimate the amount of product needed for your wall calculate the total SFF and multiply by 1.5. This equals the total number of units required.
* Wall length x wall height = SFF

Note: To achieve the maximum SFF per unit the large face should be used. When turning units to create random appearance additional material will be required.

When building double split freestanding or seating walls the maximum recommended height is 2.5 ft. Additionally these walls should be pinned and glued on each course.

Verazzo Double Split units have two finished faces of varying size. The front of the unit is .67 sq.ft. and the rear of the unit is .50 sq. ft. This should be taken into consideration when estimating the wall. These two faces average .58 sq. ft.

COLOR SAMPLE CHART



Onyx/Toffee



Ruby/Onyx



Sandstone/Brown



Onyx/Natural

Alignment Pins

Verazzo Stone's alignment pins provide a shear connector, securely holding Geo-grid reinforcement and aligning units. Two pins are needed for each unit.



Sandstone



COUNTRY MANOR & STONEGATE

This dry-stacked, yet mechanically connected wall evokes the Old World charm of a mason-crafted wall. In a castle or home, these graceful curves, monumental columns and free-standing walls are all part of the charm of Country Manor from Keystone.

Wall Variety

For a creative design option, units may occasionally be placed vertically in the wall to provide a break of horizontal lines. To span two, six-inch high courses, use the unit with the 12-inch length. Because the fiberglass pins do not interlock in this position, use adhesive to fasten this unit in place. Be sure the unit above the 12-inch vertical unit spans beyond the six-inch width of the vertical unit, so each end of the vertical unit is covered with a horizontal unit.

Curves

Curving walls add texture to a landscape, creating a circular center patio and separating it from planting areas. Convex (outward) and concave (inward) curves can be built in both the near-vertical and the one-inch set-back walls. Because the units are finished on both sides, Country Manor can be used for free standing walls, and columns. However, these should always be built in a vertical position, as well as, each course should be adhered to each other using adhesive.

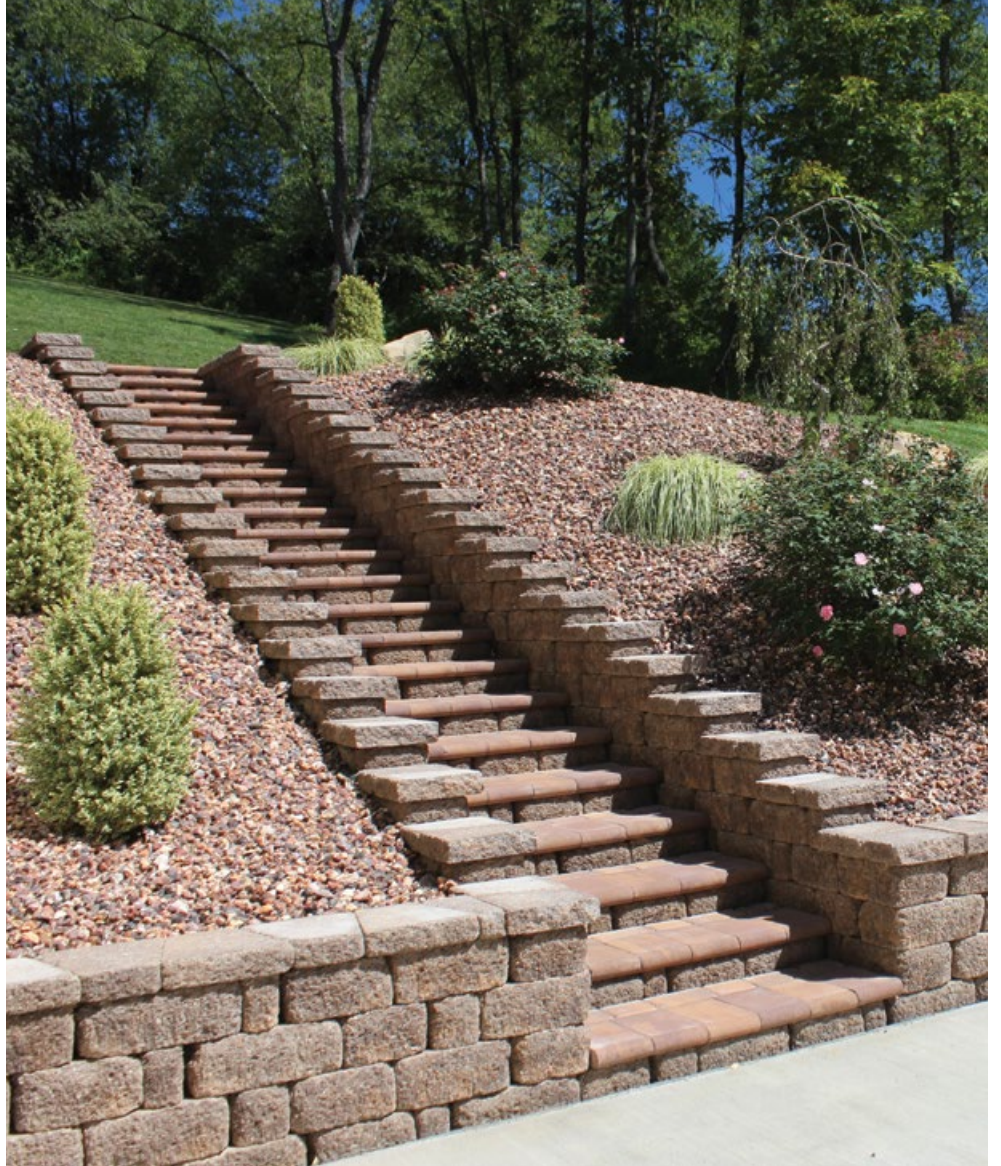

Left and Above: COUNTRY MANOR

Note: Country Manor and Country Manor Stonegate may require the use of Geo-grid even on low height walls under 3 ft. depending on application.

COUNTRY
MANOR

Keystone Stonegate Country Manor features a unique smooth face which allows for a more refined appearance. Like traditional Country Manor, Stonegate is produced in colors that enhance the natural stone like appearance of this multi-sized product.



COUNTRY MANOR STONEGATE



COUNTRY MANOR STONEGATE and COLONIAL WALL

COUNTRY MANOR & STONEGATE

Country Manor and Stonegate Country Manor each have three different sized units that provide up to six different face dimensions to achieve a wide range of flexibility for wall layout. Country Manor units are sold by the layer with six of each shape per layer, 18 units total per layer. Country Manor is also sold by the pallet, with four layers per pallet.

Country Manor Product Information

The Country Manor units can be oriented in two different positions when building. For retaining walls, the open or closed positions will work. (When using the open positions, be sure to fill in the gap with drainage aggregate). For free-standing structures, use the closed alignment position.

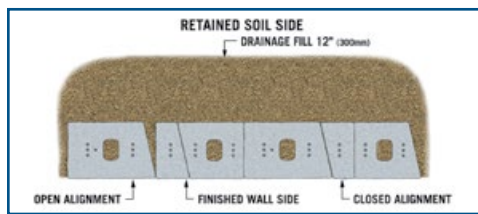
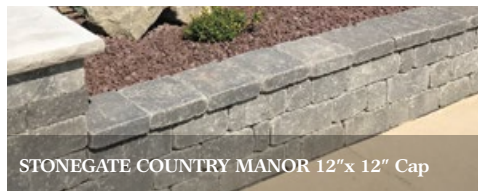

For installation of Geo-grid with pinned systems refer to Geo-grid Installation on pages 48-49.

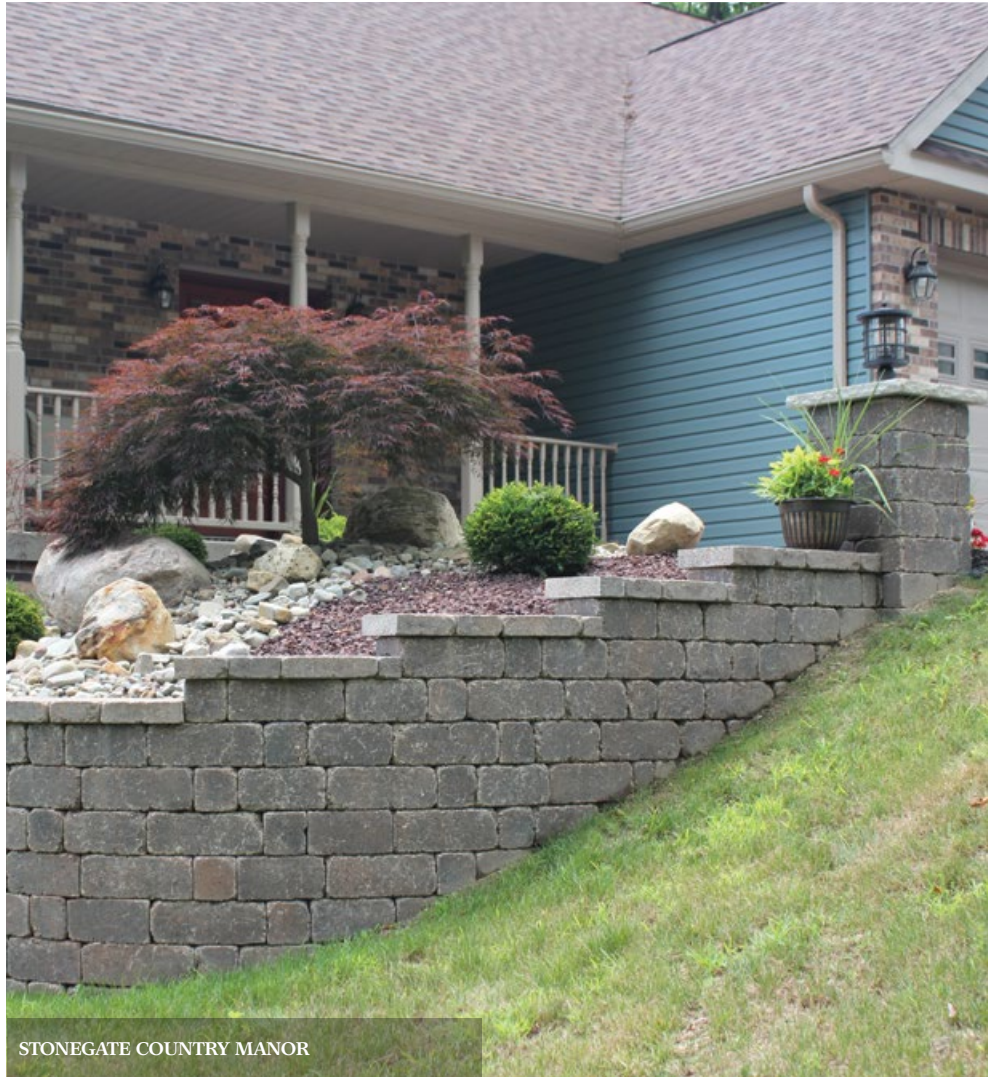

PRODUCT SPECIFICATIONS

**Country Manor Large Unit*



**Stonegate Country Manor Large Unit*



10" D, 6" H, 16"-14" W
Weight: 60 lbs

**Country Manor Medium Unit*



**Stonegate Country Manor Medium Unit*



10" D, 6" H, 12"-10" W
Weight: 40 lbs

**Country Manor Small Unit*



**Stonegate Country Manor Small Unit*



10" D, 6" H, 6"-4" W
Weight: 25 lbs

**Country Manor Cap Unit*
(Two sides textured)

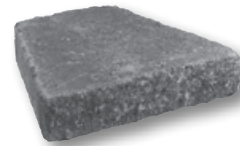

**Stonegate Country Manor Cap Unit*
(Two sides finished)



12" D, 3" H, 14"-8" W
Weight: 24 lbs

**Stonegate Country Manor 12" x 12" Cap Unit*
(Finished all sides)



12" D, 3" H, 12" W
Weight: 34 lbs

*For large, medium and small units, divide total SFF by 8.46 for an "open" alignment or 7.74 for a "closed" alignment to yield the average number of layers needed. 8.46 is the maximum yield per layer depending on the orientation of the units. (i.e. closed or open alignment). For example: 55 SFF divided by 8.46 = 6.5 layers (on average).

*For the Country Manor Cap Unit, multiply the total wall

length by 1.1 to yield the average number of Cap Units needed. (On average, two cap units are needed for every 22 inches of wall length).

*To estimate the amount of product needed for your wall, complete the Estimating section (page 54) and apply the calculations to the equation for the desired product. For example: 55 Total Wall Length x 1.1 = 60 cap units (on average).



12" x 12" Cap Unit
also available in Onyx

COLOR SAMPLE CHART

Country Manor



Onyx/Natural



Ruby/Onyx



Sahara



Onyx/Toffee



Sahara/Brown



Sandstone/Brown

Stonegate Country Manor



Onyx/Natural



Ruby/Onyx



Sahara



Onyx/Toffee



Sahara/Brown



Sandstone/Brown

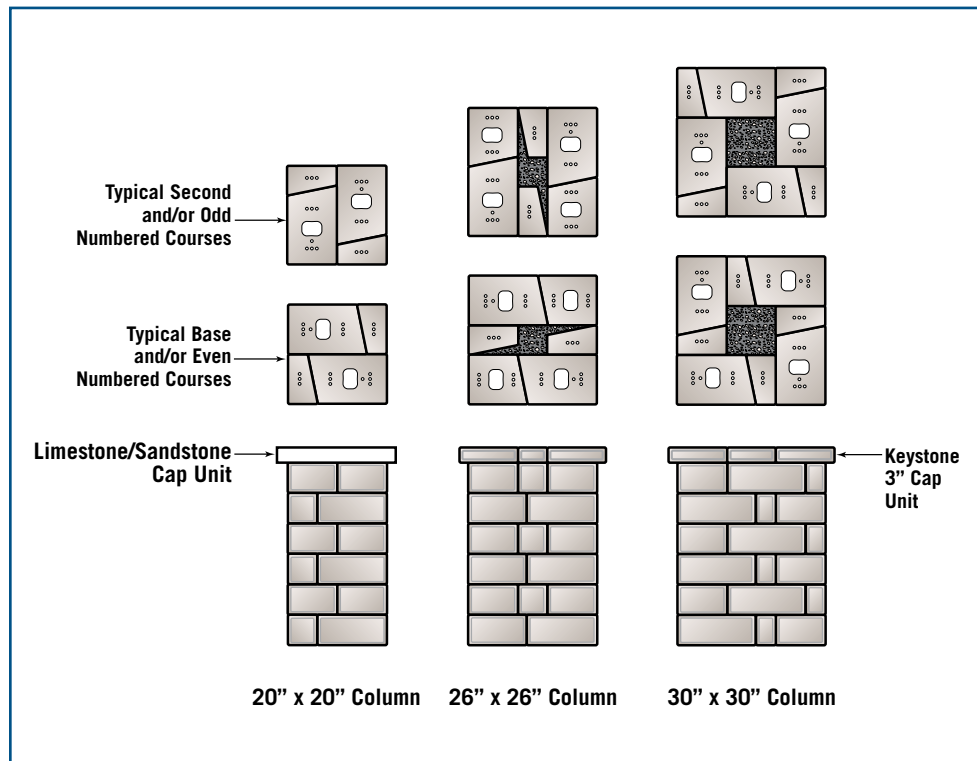

Country Manor Pins

Keystone's Country Manor "shouldered" Pinned System features high strength fiberglass pins that provide a shear connector, securely holding Geo-grid reinforcement and aligning units. Pins fit all three size units. Thirty pins are needed for each layer.



COUNTRY MANOR & STONEGATE



STONEGATE COUNTRY MANOR



STONEGATE COUNTRY MANOR

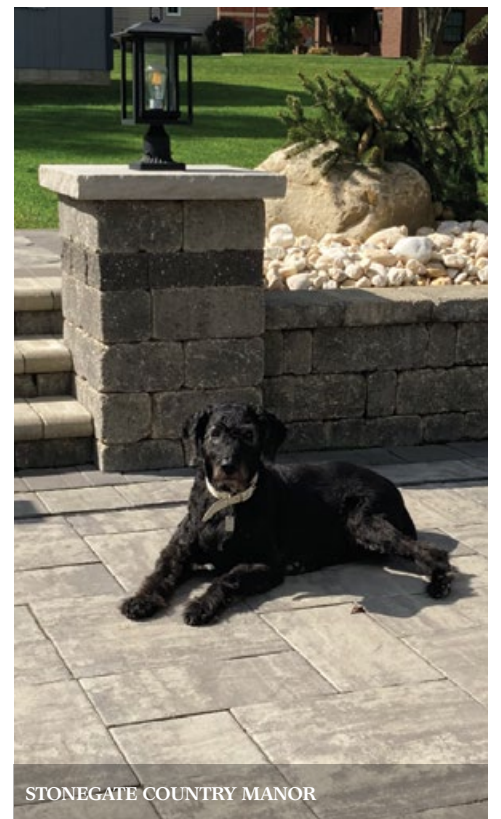

STONEGATE COUNTRY MANOR

COUNTRY MANOR



KEYSTONE
Stonegate[®]
COUNTRY MANOR[®]

Left and Below: COUNTRY MANOR and STONEGATE



COLONIAL WALL

Colonial Wall's highly versatile one unit design can help you create distinguished outdoor living space in your backyard.

Bauer's Colonial Wall has an aged weathered appearance that gives it the charm and character of costly natural stone products without the high price. Here are just some of the infinite number of landscape design ideas you can imagine with Colonial Wall.

- Outdoor Kitchens & Grill Areas
- Outdoor Bars & Counters
- Outdoor Fireplaces
- Sitting Walls
- Stately Columns
- Mailbox Columns
- Landscape Edging
- Low Height Retaining Walls
- Fence Piers
- Steps



COLONIAL WALL

INSTALLATION GUIDE

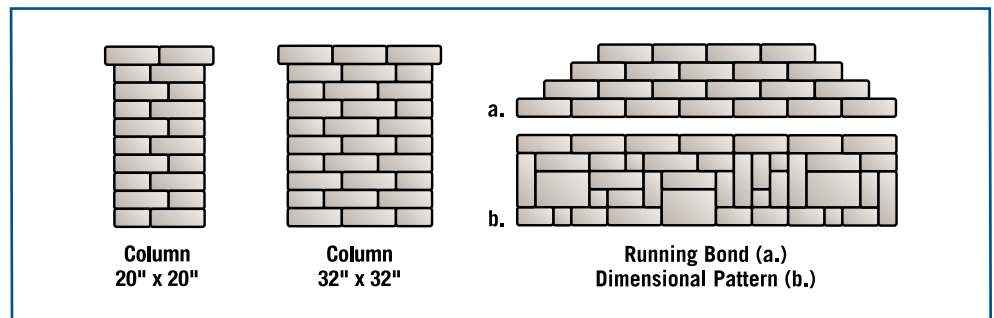
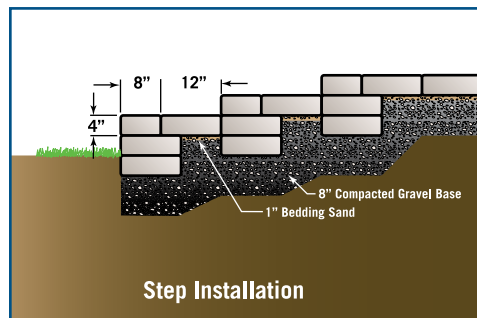

Colonial Wall Installation Instructions:

Step 1: Determine wall location and dig a shallow trench for wall base approximately 8 inches deep and 14 inches wide. Place granular leveling pad material 4 to 6 inches thick in trench. Compact and level the granular material. If there are any grade changes along base of wall, create stepped leveling pad as required. Always start wall at lowest elevations, working to highest elevation.

Step 2: Place and level the first unit, leveling it front to back and side to side. Facing the wall front, base units should be installed with the unit 4 inches high by 8 inches wide by 12 inches deep, if wall is retaining soil. Continue to level each additional unit to each adjacent unit. Complete the base course before proceeding to add courses.

Step 3: Due to the dimensional nature of the Colonial Wall units, the second and subsequent courses can be stacked in different directions creating varying patterns within the wall face. As an alternative, units can be stacked in a running bond pattern, meaning each additional course of units will sit on one half of each of the units below it. Because this is a gravity wall, height should be limited to a maximum of 2 feet, and all units should be glued to each other with an approved masonry construction adhesive. If this wall is acting as a retaining wall then the wall should be 12 inches front to back. Cutting of some units may be required on curves, or to create dimensional patterns. Backfill as you continue up with additional courses using 1/2 to 3/4 inches clean angular stone to provide drainage. As an option a 4 inch perforated pipe may be installed behind the Colonial Wall units at the base of the wall.

PRODUCT SPECIFICATIONS

Colonial Wall



8" D x 4" H x 12" W
 Weight: 29 lbs

Notes:

1. Colonial Wall units must be glued using a quality masonry construction adhesive.
2. Maximum wall height is 2 feet, column height 3 feet. Walls or columns exceeding maximum height should be reviewed by a qualified engineer. Surcharge loads, or slopes will put additional pressure on the wall, and should be considered in the overall wall height and construction.

* To estimate the amount of product needed for your wall calculate the total SFF* and multiply by 3. This equals the total number of units required.

* Wall length x wall height = SFF

COLOR SAMPLE CHART



Onyx/Natural



Ruby/Onyx



Sahara



Onyx/Toffee



Sahara/Brown



Sandstone/Brown



Onyx

COLONIAL WALL

Note: Colonial Wall is also available in Onyx for banding and accents as shown in the photo below.

All photographs below are COLONIAL WALL.

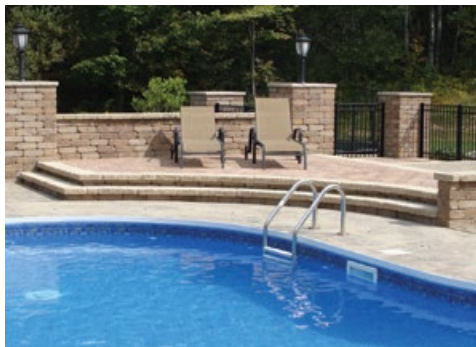

HARDSCAPE PRODUCTS—FIREPLACES



COUNTRY MANOR Fireplace



STONEGATE COUNTRY MANOR Fireplace

*Bringing the Indoors Outside...
where one space ends another begins.*

The outdoor living concept can include many different aspects, from fire pits, bars and seating areas, to grill stations, and custom built fireplaces like those pictured on the next few pages. These fireplaces can be built using Country Manor, Stonegate, or Colonial Wall. We also have high quality drop in stainless steel inserts available simplifying construction using your choice of product. As an option custom mortared fire brick boxes can be constructed if you prefer a larger opening.

BAUER
COMPANY, INC.
HARDSCAPE PRODUCTS



COLONIAL WALL Fireplace

HARDSCAPE PRODUCTS—FIREPLACES

If you're looking to add a functional and dramatic element to your outdoor room, then consider an outdoor fireplace using Innovative Hearth Products (IHP) stainless steel insert from Bauer.

America is moving outdoors, and IHP's fireplace insert is the perfect complement to any outdoor living area. This outdoor fireplace insert can be used with Colonial Wall, Keystone Country Manor, or Keystone Country Manor Stonegate to create a stunning addition to your project. The IHP insert features a clean, one piece brushed stainless steel face with no exposed seams or screws, stainless steel spark screens, and even a solid stainless steel log grate. These units also feature a realistic textured refractory brick liner in natural white.

The IHP insert is available in both a 36" or 42" unit, and is wood burning ready, or as an option it can easily be adapted for gas log usage.



COLONIAL WALL Fireplace

WRE3036WS
IHP 36" white stacked
stainless steel insert.



Note: When constructing the fireplace, a solid piece of steel angle needs to be installed above the insert opening to carry the load of the retaining wall units installed above the opening.



COUNTRY MANOR STONEGATE Fireplace



COLONIAL WALL Fireplace

HARDSCAPE PRODUCTS—FIRE PITS

Bauer offers an easy to construct Fire Pit that you can build yourself in an afternoon and enjoy that evening!

Enjoy your patio on a cool summer evening with the warmth and atmosphere an outdoor fire pit can bring. Whether it's an evening for two or your entertaining the neighbors, this easy to construct fire pit will provide years of outdoor enjoyment. Bauer's outdoor fire pit is constructed using the Keystone Country Manor or Stonegate Country Manor caps. It features a steel insert that slips into the opening, protecting the block from excessive heat. It is available as a standard steel ring with an optional cooking grate. The fire pit is designed to be wood burning, however if you prefer you can have a professional install a gas log insert.

The interior width of the fire pit opening is 27" in diameter. The overall width of the fire pit is 51" in diameter. The Bauer fire pit can be constructed directly on a paver patio as shown, or as an option it can be built in the backyard on a minimum 6" compacted stone base.

We also offer a square fire pit insert. This insert is designed to be used along with our Colonial Wall and Country Manor products to create an attractive and functional outdoor living element sure to enhance any backyard entertainment area. Available with or without cooking grate. The inside dimension is 27" x 27" and the outside dimension of the square fire pit is 44" x 44".



INSTALLATION GUIDE

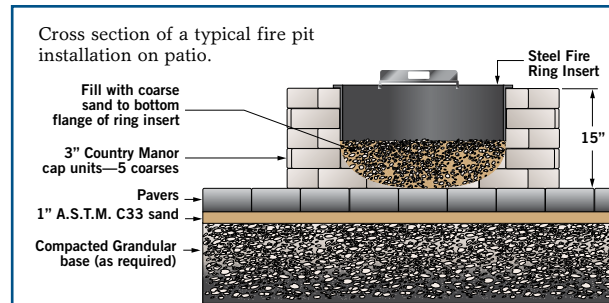
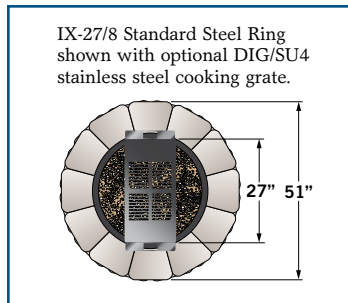

COLONIAL WALL seating area with COUNTRY MANOR Fire Pit



VERAZZO STONE seating walls with custom sandstone cap and COUNTRY MANOR Fire Pit

INTEGRAL LIGHTING

Integral Lighting offers a unique and innovative solution to hardscape lighting. Lighting can be used to illuminate a walkway or to highlight steps, walls and columns.

Integral Lighting's full line of low voltage hardscape lighting products are now available at Bauer. These lights are easy to install in new or existing construction and can light up stairs and pathways or highlight columns. Lights are available in multiple finishes to accent most retaining wall products, and are available in both halogen and L.E.D. style fixtures.

Contact Bauer or your Authorized Dealer for more detailed information.



LED Fixture—IL600

Mono-color powder coated stainless steel—6 colors for IL600



Carbon .700



Textured Bronze .710



Platinum .730



Sandstone .770

Note: Light Concrete, Dark Concrete, and Solid Antique Brass not pictured. Additional products and finishes available.

See www.integral-lighting.com for a complete selection.



Single Lamp—IL6



Dual Lamp—IL18



Solid metals—4 finishes for IL6 & IL18



Solid Copper .105



Solid Brass .125



Brushed Stainless Steel .150

Powder Coated Aluminum—15 colors for IL6 & IL18



Black .200



Bronze .225



Clay .250



Putty .275



Brick Red .300

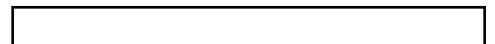

White .325

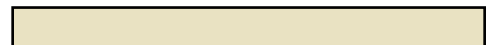

Bone .350



Sand .375



Mud .400



Terra-cotta .420



Pebble .450

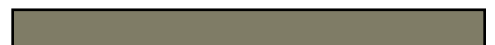

Stone .475



Slate .500



COLORFALLS

Enjoy the sights and sounds of a soothing lighted falls in your next landscape project. Available in multiple colors, Colorfalls is an easy, virtually maintenance free way to add a water feature to your patio or backyard.

The Colorfalls system is specifically designed for use with hardscape materials, and is a perfect fit for incorporating into formal backyard patios and retaining walls. Colorfalls can add a breathtaking new dimension by introducing the element of water to your outdoor entertainment area. Colorfalls is available in several different colors to accent your project while bringing the relaxing sound of a waterfall creating your own backyard oasis, and it's lighted so you can enjoy it both day and night.

The 24" Colorfalls Kit comes with everything required to easily install it into your next hardscape project. Water is recirculating and is virtually maintenance free. The kit includes a pump, power supply, pipe and fittings, basin, and L.E.D. lighted falls head. Colorfalls is also available as a 12" or 36" kit by special order. Contact Bauer or your local Authorized Dealer for more information.



12" Colorfalls Kit



24" Colorfalls Kit

Note: In winter climates, basin should be drained and the pump and falls head removed to avoid possible damage from freezing.



Below and Right: COLONIAL WALL



Create brilliant effects with Atlantic's Color Changing Colorfalls light bar offering 16 different color options.



PAVING STONE PRODUCTS

Bauer offers Nicolock's full line of paving stones to create dramatic patio areas, stately driveways and inviting walkways. Nicolock's products can complement any hardscape project with multiple colors, styles and finishes.

Nicolock produces a complete line of interlocking concrete paving stones in over 25 different colors, which consist of both solid and multi color blends. With an extensive product line and large color selection, Bauer can provide you with infinite possibilities for your landscape projects. The Nicolock organization, a division of Nicolia Industries, is backed by over 50 years of experience in the production and supply of quality concrete products. Based out of Lindenhurst, NY, with locations in North Haven, CT, and Frederick, MD, Nicolock operates a high-tech, multi-plant manufacturing facility and services the regional Northeast and Mid Atlantic Region.

We at Bauer are very excited to be able to offer this premier line of interlocking paving stones in the Tri-State Area. These are just a small sample of all the different Paving Stones available. Contact Bauer for a complete Nicolock brochure, visit www.nicolock.com or stop by your local Bauer Authorized Dealer today.



STONE RIDGE: Westchester Blend
Border: 6" x 9" Rustico: Granite City Blend



STONE RIDGE: Granite City Blend
Border: HOLLAND STONE: Charcoal



STONE RIDGE: South Bay Blend
Border: RIDGE BRICK: Raven

NICOLOCK
We're paving a whole new way.

RIDGE BRICK

Oversized brick shape • Textured riven surface
Slightly chamfered edges
(Use as field paver or as a border for Stone Ridge)

PRODUCT SPECIFICATIONS

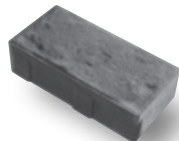

width	length	thickness	pcs./s.f.	s.f./pallet	pcs./pallet	lbs./pallet
4-1/2"	9"	2-3/8"	3.63	110	400	3,144

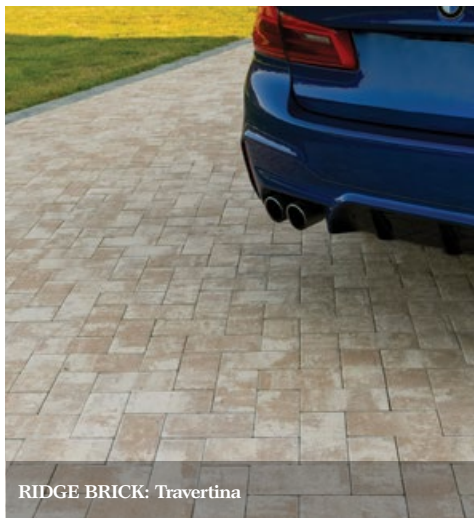

RIDGE BRICK: Travertina

HOLLAND STONE

Classic brick shape • Flat surface • Chamfered edges

PRODUCT SPECIFICATIONS

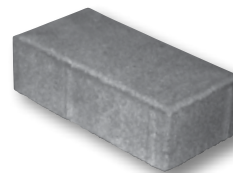

width	length	thickness	pcs./s.f.	s.f./pallet	pcs./pallet	lbs./pallet
4"	8"	2-3/8"	4.5	120	540	3,360

STEPPING STONES

Effective in protecting lawns from traffic
Create winding paths across gravel, mulch or grass

PRODUCT SPECIFICATIONS

width	length	thickness	pcs./s.f.	lbs./pallet
22"	16-1/2"	1-1/2"	20	777



STEPPING STONES: Gironde



HOLLAND STONE: Granite City Blend



HOLLAND STONE: Oyster Blend

PAVING STONE PRODUCTS

STONE RIDGE

Multi-size rectangular shapes
Slightly textured riven surface • Slightly chamfered edges
(Can be combined with STONE RIDGE XL)

PRODUCT SPECIFICATIONS

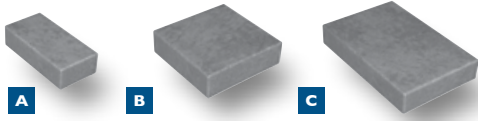

	width	length	thickness	pcs./s.f.	s.f./pallet	pcs./pallet	lbs./pallet
A	4-3/8"	9"	2-3/8"	3.8	110	130	3,080
B	9"	9"	2-3/8"	1.9	-	60	-
C	9"	13-1/2"	2-3/8"	1.3	-	50	-

Sizes not sold separately.

STONE RIDGE XL

Multi-size rectangular shapes
Slightly textured riven surface • Slightly chamfered edges
(Can be combined with STONE RIDGE)

PRODUCT SPECIFICATIONS

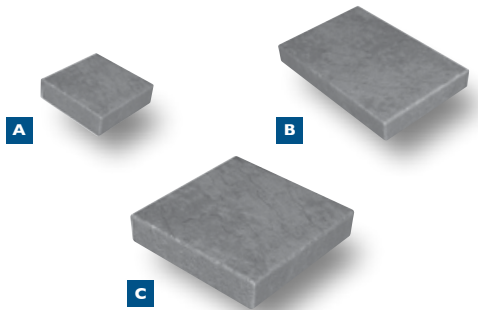

	width	length	thickness	pcs./s.f.	s.f./pallet	pcs./pallet	lbs./pallet
A	9"	9"	2-3/8"	1.9	110	20	3,080
B	9"	18"	2-3/8"	.93	-	50	-
C	18"	18"	2-3/8"	.46	-	20	-

Sizes not sold separately.

[Not recommended for vehicular traffic]



STONE RIDGE: Granite City Blend



STONE RIDGE: Westchester Blend



STONE RIDGE: Westchester Blend



STONE RIDGE XL: Granite City Blend



STONE RIDGE XL: Chesapeake Blend

HARDSCAPE ACCESSORIES & TOOLS

Bauer offers a comprehensive line of tools and accessory products. Using the right tools will add to the ease of installation and can improve your overall project. Check with an Authorized Dealer in your area for availability.

SLEEVE-IT by STRATA

SLEEVE-IT™—Don't wait until the retaining wall is built to consider fence requirements. The Sleeve-It™ System works within any new wall construction, providing easy code compliant fence installation perfectly in every way.

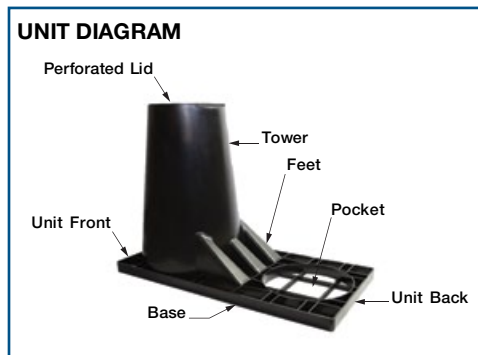

Natural Limestone and Sandstone— Bauer offers natural limestone and sandstone caps sized to finish off columns made from our products.



IQ Power Tools—The Bauer Company is pleased to announce our partnership with IQ Power Tools to bring you the latest in OSHA Compliant Saws.

We are your source for the new iQMS362 dust control saws. We also carry the necessary parts needed to maintain your saw such as the annual tune up kit. The kit will include the three basic parts a filter, table louvers, and motor brushes that will keep your saw running at it's best.

Additionally a dressing stone should be used to periodically clean the blade. We include one with each saw purchased and you can purchase additional stones to keep your blade sharp, clean and ready for your cutting needs.

- Speed, accuracy, and the ability to cut a wide range of masonry materials.
- Cut brick, pavers, stone and veneer with un-matched precision.
- 16.5" blade allows for a 5.5" depth and a full 24" length of cut.
- Cuts up to 40% faster than any other masonry saw in its class.
- Easy to move and transport, ideal for any location, readily available power.

- High-flotation tires allow one person to move over rough jobsite terrain.
- Integrated stand with a gas-shock powered lifting/lowering mechanism.
- Operates on standard 120v and 20 amps.
- Workers' health, safety and compliance with OSHA regulations.



HARDSCAPE ACCESSORIES & TOOLS



Snap Edge—The premier edging for installation of paving stones. Snap Edge can be used for both curves and straight areas eliminating the need for multiple edging types.



Introducing EdgeCrete— SEK-Surebond's Paver Restraint In A Bag. EdgeCrete is a fiber reinforced, polymer modified concrete edge restraint designed for paver and natural stone applications on an open graded or permeable base. It also can be used with paver and natural stone applications on a standard base. Just mix 1/2 gallon of water with each 50 lb. bag of EdgeCrete and install following instructions.



Polysweep— delivers superior strength and long-term durability, not gimmicky claims and false promises. PolySweep's time-tested, original formula provides reliable, haze free performance and is never tricky to install. For hardscape projects that matter, PolySweep is the only choice that delivers solid performance and value. Polysweep is available in four different colors, and as a standard or wide joint formula.



PS-1500 RJS Reactive Resin Joint Sand System— is a one-part resin sand that offers a superior strength and durable ready-to-use solution for stabilized sand joints that can be installed rain or shine. It is made with a new generation synthetic resin that hardens when it reacts with the air. It can be used in new or existing installations to create beautiful yet extremely durable hardened sand joints that will withstand the rigors of residential vehicle traffic and harsh freeze/thaw conditions.



SEK Paver Restraints

- Snap Edge, Low Profile, EdgeCrete, PermEdge & Barrier
- Superior Strength Edging For Pavers & Natural Stone
- Standard, Open Graded & Permeable Applications



PolySweep Polymeric Sand

- Same Great Haze Free Formula Since 2008
- Superior & Long Lasting Cohesive Strength
- Lifetime Warranty & No Haze Guarantee



Surebond Sealers

- Field Proven For Over 30 Years
- Immediate Application/Breathable
- Experienced Expert Field Tech Support



Surebond Cleaners

- Complete Hardscape Restoration Line
- Multi-Use & Specialty Cleaners
- Safe, Powerful & Fast Acting

INSTALLATION

To the right are four photos depicting specific installation steps which are typical of the beginning steps in constructing ALL Keystone Retaining Wall products.

Step 1: Prepare the base leveling pad. Excavate the base trench to the designed width and depth. Compact the base trench soils prior to placing any stone in the trench. Start the leveling pad at the lowest elevation of the wall. Level the prepared base with a minimum six inches of well-compacted angular granular fill. Keystone recommends additional trench depth for below grade placement of Keystone units on a ratio of one inch below grade for each eight inches of wall height above grade (to a maximum of three units buried.) This lowers the base course below grade locking the wall in place and also helps prevent erosion and scouring at the base of the wall. The base trench should be wide enough to allow for the unit and drainage zone. Walls built to a level condition on a sloping grade require a stepped base. It is best to work out the stepped base as the wall steps up in elevation.

set-back. When constructing curved walls, use the front pin position for best results. This will minimize any gapping or binding on curves.

Step 6: Capping options. Install Keystone caps. The Country Manor Cap is a three inch high concrete unit that has two textured sides, allowing the unit to have either side as



Step 2: Install the base course. When installing the first course, be sure the pinholes are face up. Place units end-to-end with corners/edges touching and be sure each unit is level—side to side and front to back. Use a string line across the back edge of the units to ensure that the wall is straight. Place a 4" perforated drainage pipe behind 1st course. This base course is critical for accurate and acceptable results.

Step 3: Insert the fiberglass pins. Place two pins in each unit. With the "pinned" system, it is easy to build a near-vertical wall, a set-back wall or a wall where intermittent and random units project from the wall face. For a vertical design using Country Manor or Verazzo Stone, place pins in center holes. Use the rear holes for one-inch set back. The front hole position allows random units to be pulled forward from the wall to create a more natural variation to offset the wall. For a 1/4 set-back in other Keystone pinned products, place pins in front holes. Use the rear holes for 1-1/4 inch

Step 4: Install drainage fill, backfill and compaction. Once the pins have been installed, fill in all voids—in and between Keystone units—using 1/2 to 3/4 inch clean angular crushed stone. Place drain zones and 4" perforated pipe behind the units as required to achieve a minimum two foot depth of drainage zone from unit face. Compact material in unit cavities appropriately to eliminate settling. When clay or poor soils are present we recommend that the entire Geo-grid zone be backfilled with clean angular crushed stone.

Step 5: Install additional courses starting at the straight wall areas. Place units over pins and center over joint of units below. When stacking the units, pull them toward the face of the wall until it makes full contact with both pins. If pins do not connect with channel but align in open core of upper unit, place drainage fill in core to provide unit interlock with pin. Additionally adhesive may be used to secure small units or any other areas that may not align with pin.

a finished face for straight and curved wall applications. The 12-inch depth from face to face of the Universal Cap allows for a one-inch overhang or "shadow" effect over each side of the wall. (This shadow effect can be eliminated on retaining walls by pushing the cap flush with the wall plane. Use adhesive to fasten caps in place.)

BAUER
COMPANY, INC.
HARDSCAPE PRODUCTS

Building Terraces

Terraces are a pleasing way to build a taller retaining wall. Closely spaced terraces need to be reviewed by a qualified engineer to determine overall stability. Terraced walls should be analyzed as a complete wall system versus an individual wall, unless they are spread greater than twice the wall height of the lower or first wall and the soils are free draining and granular in nature.

Avoid stack bond situations with ALL Keystone products

NOTE: It is best to construct the wall using the units as they are stacked on the shipping pallet. There is no pattern repeat, so work with random units. It is best to avoid stack bond, or when a vertical joint line between adjoining units continue over several courses.

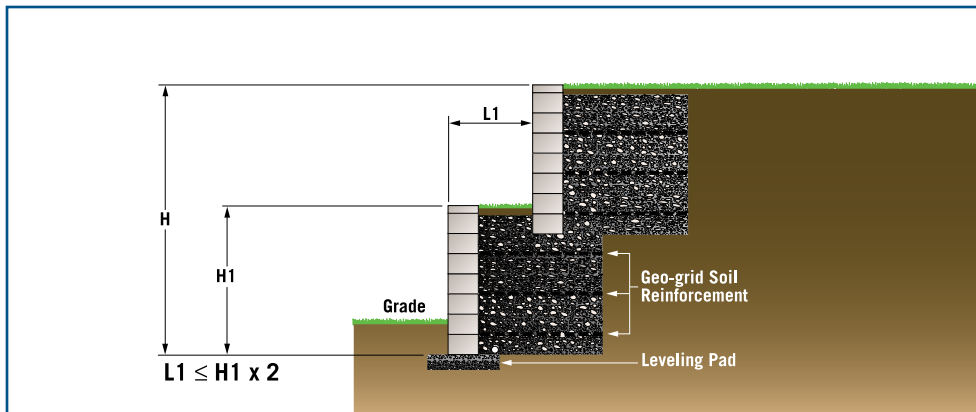

Above: Cross section of a closely spaced terraced wall

Below: Cross section of an independent terraced wall

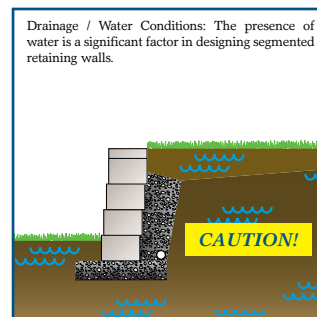
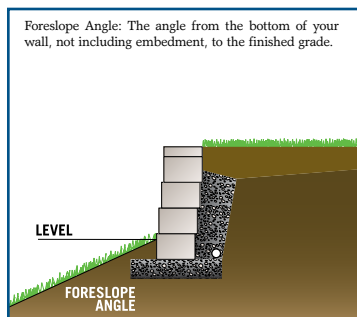
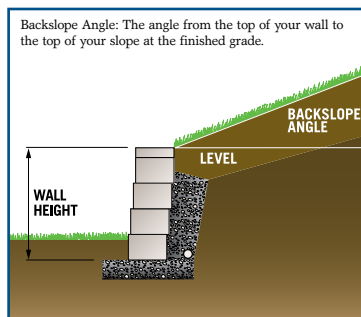
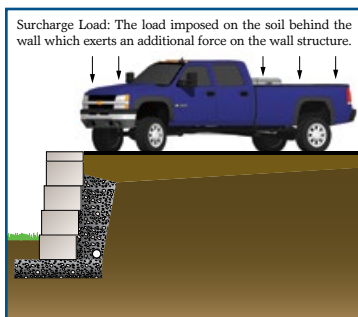
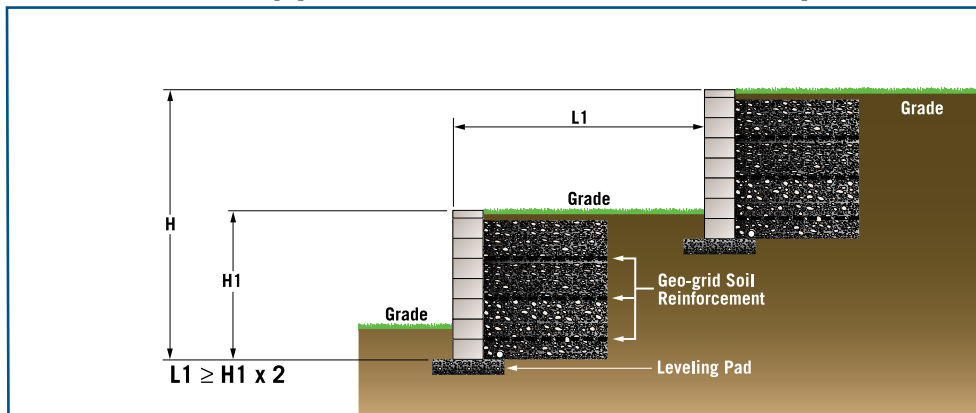

Assessing Wall Performance

Descending slopes, as illustrated at bottom right, are a critical condition, and should be reviewed by a qualified engineer prior to construction.

Contact Your Local Authorized Dealer

After you have completed your sketch, and selected a product type, take your measurements to your local Authorized Dealer. They can assist you in preparing a final product estimate for your project. Additionally most Authorized Dealers have displays at their yard to assist you with product and color selection. To locate an Authorized Dealer near you call 1-800-419-WALL or visit our web site at www.bauerblock.com and click on Where to Buy.

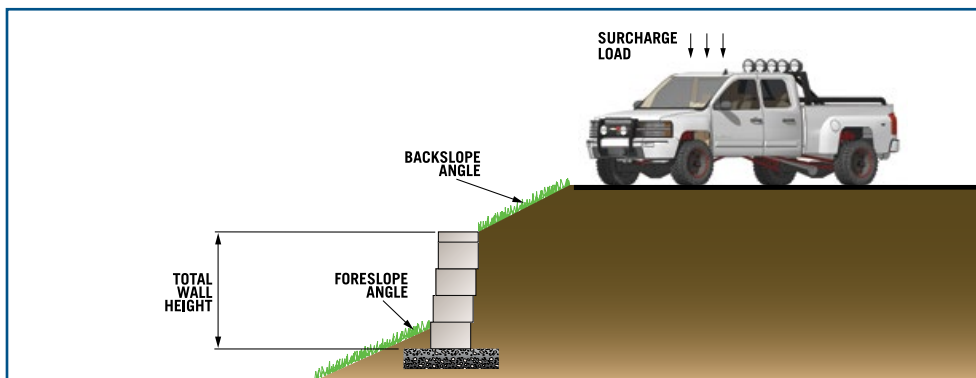

Above: Sample cross section

Below: Wall embedment when building on slopes

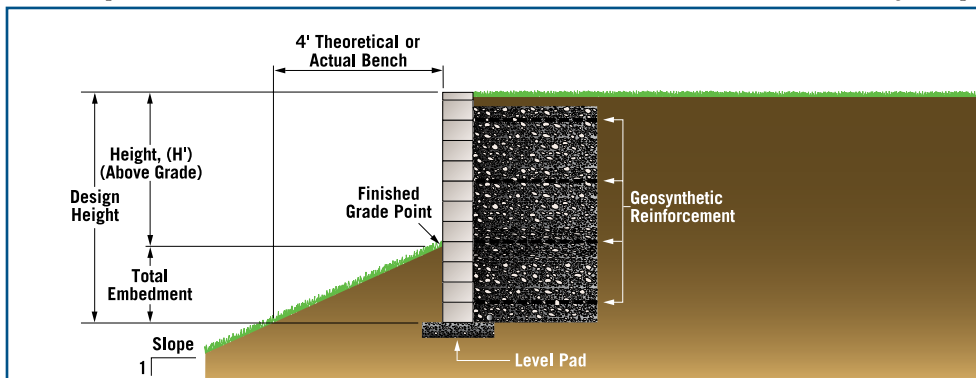

GEO-GRID REINFORCEMENT

Geo-grid is used to reinforce and stabilize the backfill area behind a wall. Additionally through its connection with the Keystone fiberglass pins, the Geo-grid acts as a tieback to maintain the position of the wall face. Retaining walls 3 feet or higher may require Geo-grid.

Bauer distributes the Stratagrid line of polyester Geo-grids through our Authorized Dealers. Stratagrid Geo-grids reinforce soil with their high molecular weight and high tenacity polyester yarns. The yarns are precision knitted, dimensionally stable and coated with a black UV stabilized material which provides both mechanical and chemical durability. Stratagrid is produced in multiple strengths in order to provide the most efficient design possible for your retaining wall project. Stratagrid has been proven in the lab and by its installation in literally thousands of applications over the past decade.



INSTALLATION GUIDE



The gravel is only contained by the walls of the box.



Without reinforcement the gravel collapses when the walls are removed.



Geo-grid is added between layers of gravel.



When the walls are removed the layers of Geo-grid maintain the shape of the gravel block.



The advantages of Geo-grid reinforced structure include:

- Construct walls faster; the wall structure and backfill are constructed at the same time
- Eliminates the need for deep structural footing and excavation due to flexible system design
- Provides durability; long term performance, resists effects of water, micro-organisms, alkali or acidic soils
- Allows a structural wall to be built with an architectural finish

Properties of Geo-grid

- high tensile strength
- long-term creep resistance
- open geometry for interlock
- non-degradable
- "off-the-shelf" availability

Bauer carries common roll sizes which are 6.25' W x 144' L, or 6.25' W x 288' L depending on the product. We also have smaller rolls ideal for residential applications which are 4' W x 50' L. Additionally we carry the woven geotextile fabric and the Sleeve-it product. Contact your local Authorized Dealer for more information and availability of these products.

Note: In critical situations Geo-grid may be required in walls under 3 ft. Review your project with a qualified engineer to determine requirements.

BAUER
COMPANY, INC.
HARDSCAPE PRODUCTS

Step 1: Excavate reinforced soil area. Remove existing soils in the reinforced soil area to the maximum embedment length of the Geo-grid design. Provide a generally level soil condition behind the wall units for the placement of each Geo-grid layer.

Step 2: Cut Geo-grid. Cut sections from Geo-grid roll to the specified length (embedment depth). Geo-grid roll direction is from the wall toward the embankment (check manufacturer's criteria). In most cases correct orientation is to roll the Geo-grid perpendicular to the wall face.

Step 3: Install Geo-grid. Hook Geo-grid over the fiberglass pins to ensure a positive mechanical connection between the unit and Geo-grid.

Step 4: Secure Geo-grid. Pull the pinned Geo-grid taut to eliminate loose folds. Stake or secure back edge of Geo-grid before and during backfill and compaction. Remove stakes, if desired, once backfill is placed. Place additional sections of Geo-grid, abutting each other, for continuous coverage at each layer.

Step 5: Install next course of Keystone units. Check for level with each new course.

Step 6: Place compacted backfill over Geo-grid in 6 to 8 inch lifts. Provide a minimum of six inches reinforced fill coverage prior to driving equipment over the Geo-grid with wheeled or tracked equipment. Avoid driving or turning equipment directly on Geo-grid to avoid excessive damage.



Right: Geo-grid roll direction is from the wall toward the embankment, perpendicular to the wall face.

Below: Place Geo-grid 3/4 to 1 inch back from wall face so Geo-grid will be hidden once the wall is completed.

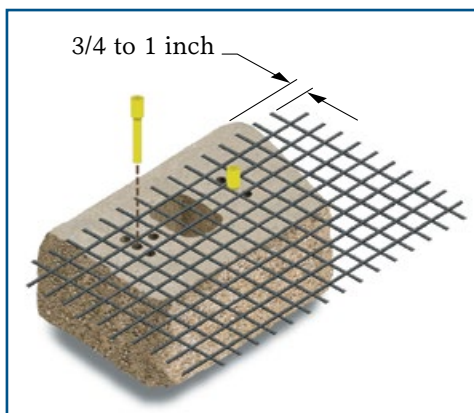

DO-IT-YOURSELF

Whether you do-it-yourself or hire a contractor, adding a retaining wall to your property can increase your outdoor living space, define a flower bed, expand your driveway, or completely change the look of your yard. Retaining walls can add beauty and function to your property, and increase the value of your home.

To ensure the success of your retaining wall project, you will first need to determine it's overall objectives and goals. Retaining walls can be used for a wide variety of applications. Whether it's a landscape wall to aesthetically enhance your property, or a structural wall to maintain a large slope or hillside, Bauer has a product that can be tailored to fit your specific application and needs. If you are considering doing your project yourself, we can help guide you in making the right product selection to insure the long term integrity of your wall no matter how large or small it may be.

No matter if you tackle your own project or hire a professional contractor, Bauer has the right retaining wall product for you. Choosing a project specific product will ensure that your wall will be functional, safe and attractive for many years to come.

Getting Started

Every retaining wall is unique, even walls of the same height can have different factors that affect the installation process and overall design. Consider these factors before you begin construction.

1. Goals

Identifying your project goals is the first step to selecting a product. Will your wall be a purely decorative addition to your property or will it also function to support a large hillside or slope.

2. Wall Height

Determining the maximum finished height of your wall will help you to select which one of Bauer's products can be used for your project.

3. Critical vs. Non-critical walls

Distinguishing which category your wall falls into will also determine which product you will be using, and whether or not Geo-grid reinforcement will be required.

Determining factors of a critical wall:

- A structure where failure would result in property damage, loss of use, or loss of life
- Wall heights exceeding three feet
- Excessive loads, such as driveways, parking lots, or structures on top of the wall

- The presence of water from natural springs, surface runoff, or water applications (streams, rivers, lakes, or ponds)
- Tiered walls (multiple walls spaced closely together)
- Walls with large slopes behind them, or any wall built on a slope
- If poor soil conditions are present, such as soft clay or rock

4. Load Bearing

How much force will be exerted on the wall. Heavy loads can be supported if accounted for during wall construction.

5. Excavation

Identifying the limits of excavation based on the product being used and the application will help to determine the amount of preparation needed, as this can be a labor intensive process.

Additional Supplies

Contact your local Bauer Authorized Dealer for these additional supplies.

- Angular gravel/limestone backfill
- Landscape fabric
- 4 inch perforated drain pipe
- Limestone sand / screenings
- Angular compactible gravel or limestone sub-base
- Geo-grid soil reinforcement

Equipment & Tools Needed

- caulking gun
- garden rake
- circular saw
- vibratory plate tamper
- eye and ear protection
- tape measure
- dead blow hammer
- gloves
- hand tamper
- four foot level
- wheel barrow
- masonry blades
- square shovel
- masonry chisel
- stakes
- mason's string
- marking pencil
- line level

Note: The size and complexity of your project will determine your specific needs.

Building Permits

The Uniform Building Code Section 106.2 requires a building permit for earth retaining structures over four feet high. A stamped engineered design may be required by some building officials. Although some locations have no provisions for an engineered design, we recommend contacting your local building inspector to determine the requirements in your area. (See Warranty on page 53).

Retaining Wall Q&A Seminar

Bauer provides informational seminars at various Authorized Dealer locations throughout the year. Visit our web site to see if there is one scheduled near you.

Design Assistance

Design Assistance is available to homeowners and contractors. It allows a preliminary design to be prepared which allows all parties to better understand the scope of work on a proposed project.

Design Assistance will insure that the contractor or homeowner takes into account the critical factors that may influence the wall and should be recommended for any of the following projects:

- Wall height exceeds three feet
- Slope at the top or bottom of the wall
- Loading on the top of the wall (drive ways, parking lots, or buildings)
- Poor soil conditions
- Presence of water
- Tiers or terraces

You may contact your local Authorized Dealer or Bauer to have your wall reviewed.

Note: This service is provided free of charge and is intended for preliminary estimating purposes only. Review by a qualified engineer should be completed prior to construction.

Residential Engineering

Residential engineering is required for more complex and critical projects—i.e. heavy loadings, extreme heights, and difficult site conditions. Many municipalities require stamped engineered drawings for wall heights as low as four feet. It is the responsibility of the property owner to check with their municipality on the specific requirements for residential engineering for projects in their area.

BAUER
COMPANY, INC.
HARDSCAPE PRODUCTS

FREQUENTLY ASKED QUESTIONS

Below you will find some of the most common questions we get in regards to installing Keystone Retaining Walls, reinforcement, foundations, installation and product warranty.

How do I choose a product?

The height and surcharge requirements of your wall will affect your product decision, so complete all of the measurements to determine the wall geometry, height and square footage (see Estimating on page 54).

For non-structural landscape walls three feet or less, the Rear Lip Systems provides an easy "one unit does it all" method of constructing walls. An integral rear lip is molded into every block unit. The lip automatically guides each new course, ensuring proper alignment and precise set-back (see Garden Wall and Legacy Stone on pages 16-17).

The Keystone Pinned System allows for taller, more critical walls and offers the choice of near-vertical or one-inch set-back options. The fiberglass pins also provide additional strength at the wall face and positive connection with Geo-grid, which allows proper pre-tensioning and resistance. The defined alignment established by the pins delivers a more precise wall face pattern that is maintained over the entire wall (see Compac III, Victorian Compac, and Verazzo Stone on pages 18-23). Also, the Country Manor and Stonegate products provide an Old World architectural finish in a Pinned System (see pages 24-29).

How do I estimate how many units I need?

Refer to Estimating on page 54 to calculate your wall area, and take these measurements to your Bauer Authorized Dealer.

What is a gravity wall structure?

Any coherent structure that solely utilizes its mass and geometry to resist the earth pressures acting upon it. All landscaping wall products and structural wall units not utilizing soil reinforcement are considered gravity walls by definition. Gravity wall structures rely on weight, depth and wall batter to achieve stability. Larger units with more depth provide greater stability than smaller units with less depth.

What is a reinforced soil wall structure?

Composite structures which utilize wall units and Geo-grid to create a stable mass that can be designed and constructed to much greater heights than simple gravity walls. Reinforced soil wall structures combine the mass of the composite structure with the strength of the Geo-grid to resist external earth pressures.

Why do some walls need reinforcement?

Geo-grid creates a stable mass that allows walls to be designed and constructed to much greater heights than simple gravity walls because it stabilizes the soil behind the wall face.

Geo-grid is used to impart tensile strength into soil structures, allowing such structures to be built taller and steeper than the soil alone would allow, or for building on soils with bearing capacities insufficient for supporting a proposed structure. Geo-grid can be thought of as performing in the soil in much the same way that reinforcing steel bars perform in the concrete.

The amount of Geo-grid required in a retaining wall structure, and the of layers of Geo-grid in the retaining wall structure, must all be determined by the specific design considerations (wall height, surcharge loadings, soil, etc.) of the individual project (see Reinforcement notes on pages 48-49).

How high can walls be built without the use of Geo-grid?

The various Keystone retaining wall systems can be constructed between two-feet and four-feet high (in ideal conditions) depending on the type of unit, soil conditions, amount of batter used and surcharge on top of wall. Due to the nature of clay soils in our region most walls will require some reinforcement. Contact Bauer to determine if your project can be built without the need for Geo-grid.

Are concrete footings ever necessary or required?

In most cases, Keystone walls can be built directly on six to eight inches of well-compacted granular base. However, there may be instances to consider the use of a concrete leveling pad. Examples of this are: applications near water, a taller wall built on soft sub-soils, or a wall that is very long (by using concrete footing, the contractor can speed up the installation process).

What is the best material on which to build the wall?

Angular crushed stone (1/2-inch to 3/4-inch), crushed gravel or limestone with fines are best for the base pad.

What materials should be used as backfill?

A clean, well-draining granular fill, like 1/2-inch to 3/4-inch angular crushed stone, is the most effective. Do not use pea gravel, rounded aggregates, sand, excavated surface vegetation or other unsuitable soil types.

How will the design of the wall affect or correct the drainage flow patterns of my site?

Since the effects of water and overall drainage flow patterns represent the most common source of problems for retaining walls, it is critical that the contractor evaluates the impact that the property drainage flow patterns will have on the wall, and the effect that the drainage flow pattern of the newly constructed wall will, in turn, have on the site.

How do soil properties affect the design of the wall?

The soil's shear strength (angle of internal friction and cohesion and moist soil weight) determines the design characteristics of the soils for use within the wall structure. The more granular the soils (the higher the friction angle and drainage capability) the more efficient the wall design and soils reinforcement will be. Granular soils can be easily compacted, resulting in superior structure performance.

Will my local building official require a design prepared by an engineer?

The Uniform Building Code Section 106.2 requires a building permit for typical earth retaining structures over four feet high. Many local building officials require a design prepared by an engineer. However, there are many locations that have no provisions for engineered design.

What do I need to prepare before I excavate?

Check with your local utility companies to make sure there are no underground pipes or cables running through the site. Your state's One Call system can arrange to have all of your utility lines marked.

Ohio Utilities Protection Service
1-800-362-2764
(www.oups.org)

Pennsylvania One Call System, Inc.
1-800-242-1776
(www.pa1call.org)

Miss Utility of West Virginia, Inc.
1-800-245-4848
(www.wv811.com)

BAUER
COMPANY, INC.
HARDSCAPE PRODUCTS

ABOUT THE BAUER COMPANY, INC.

BAUER
COMPANY, INC.
HARDSCAPE PRODUCTS



Follow us on Facebook and Instagram



Our mission is to combine the highest quality products with an unmatched level of market and technical support. It is a goal that we continue to embrace even as our customer base grows.

The Bauer Company, Inc. is a subsidiary of The Snyder Associated Companies, Inc. and has been the exclusive manufacturer of the Keystone Retaining Wall Products in the Tri-State region since 1995.

Keystone Retaining Wall Systems is the premier name in segmental wall products in the United States and around the world. The advantage of Keystone is the ability to provide an attractive finish, while ensuring stability with its positive fiberglass pinned connection.

With our state-of-the-art manufacturing facility, and complete line of products and colors, Bauer is positioned to assist you in providing the right product solutions for your retaining wall project.

Bauer offers a wide variety of Keystone products, with different sizes, shapes, face textures, and colors which continue to evolve as the market changes. This gives you the ability to select the right product for your individual needs, ensuring lasting performance.

Whether you are a do-it-yourself homeowner or a professional contractor, Bauer's staff of experienced knowledgeable professionals offer service and support to assist you with your retaining wall project. We continually identify critical factors to ensure the structural and architectural integrity of your project. Bauer offers installation seminars, tools, and structural evaluations through its network of Authorized Dealers conveniently located throughout the Tri-State region.

The Snyder Associated Companies, Inc. was formed in 1976 to provide management for all of the Snyder subsidiaries, which include retail, manufacturing, and service industries. Among these are Allegheny Mineral Corporation, Armstrong Cement and Supply, and Glacial Sand and Gravel. These three companies supply the raw materials required to manufacture Bauer retaining wall products. This relationship allows Bauer to maintain the consistency and quality of our retaining wall products to the marketplace.

Door-to-Door Shipping

Bauer shipping services are done via an off-loading boom truck. This allows, in most instances, the convenience of materials being placed close to the wall site, therefore minimizing the amount of lifting and transporting for the homeowner. Bauer maintains a fleet of these trucks which helps to minimize delivery times in the busiest seasons. As an alternative, we also offer delivery by truck with a special forklift attached which in most cases can deliver material right to the wall site. This service is available for an additional fee. Additionally materials may be shipped on a flatbed if off-loading can be done by the property owner. Please contact your local Authorized Dealer to arrange delivery of your materials.



Note: Property damage—i.e. driveway or sidewalk cracking, as a result of our trucks is the sole responsibility of the property owner. Our drivers may at their discretion refuse to drive over walkways or on driveways if they deem the conditions unsuitable.



PRODUCT WARRANTY

Each retaining wall unit manufactured by The Bauer Company, Inc. comes with a residential Limited Lifetime Warranty to the original purchaser. All dry cast retaining wall products meet or exceed ASTM C-1372 specifications. If a product installed according to the manufacturers recommendations deteriorates due to natural causes, The Bauer Company, Inc. will replace such units without cost to the original purchaser providing proof of purchase (original receipt and pallet ID tag) Due to natural weathering of concrete products color matching of any replacement material cannot be guaranteed. The Bauer Company, Inc. disclaims any warranty with regard to color, color consistency, or surface composition due to natural variations in raw materials. Efflorescence, a common whitish deposit found on many concrete products occurs naturally and no warranty or liability is expressed or implied for this condition.

The exposed face of retaining wall units can become stained due to mold, dirt or mineral deposits in the backfill soil. Cleaners and sealers are available to address these conditions.

This warranty shall not apply to any units that are damaged, defective, or fail to meet the warranty standard due to improper installation, chemical contact, structural design, or excessive and unforeseen site conditions beyond The Bauer Company, Inc. control. The Bauer Company, Inc. responsibility is limited to its products only, any installation costs or freight associated with replacement material is not covered by this warranty and is the responsibility of the property owner.

The above warranty is the exclusive limited product warranty. All other warranties, expressed or implied, including warranties of merchantability or fitness for a particular application, are disclaimed.

Please see www.nicolock.com for Nicolock product warranty.

Disclaimer:

Bauer reserves the right to improve our products and make changes in the specifications and design without notice. The information contained in this brochure has been compiled by Bauer and to the best of our knowledge is accurately represented in the applications which are illustrated.

Product Color:

The colors shown are to be used as representations or guidelines only. Colors can vary slightly from one production run to the next due to variations in the natural materials used for manufacturing. To assure random color distribution, it is recommended that individual blocks be mixed from different pallets. Product, color, shape, size, or style may change without notice. Not all colors are available in all shapes or styles. Check with a Bauer Authorized Dealer or sales representative for availability.

What are the white stains on my wall?

White stains can present as efflorescence a whitish powder-like deposit, which sometimes, but not always appears on concrete products. The deposit is the residue of a soluble salts carried to the face of the product by moisture and left on the surface as a dry powder following evaporation of the moisture. This is a naturally occurring phenomenon and can occur in any concrete product. No responsibility for efflorescence can be accepted by the concrete product manufactures, including manufactures of concrete retaining wall products, since any normal concrete contains calcium hydroxide, the natural result of mixing cement and or lime with water. Calcium hydroxide combines with carbon dioxide in the air to form calcium carbonate, which then appears as a whitish deposit. Efflorescence must be taken for what it is a natural occurrence in a product made from natural raw materials. Additionally, some whitish deposits can be the result of mineral buildup and lime run.

Where do the salts and minerals come from?

These salts and minerals can be found in the native soil, the stone used for base or backfill, or in the sand, stone or cement used to manufacture concrete products.

How Does It Happen?

These salts and minerals can dissolve in the ground water, rainwater, or water, which is added in the process of mixing the concrete. They then progress to the drying surface of the concrete by means of a capillary action. Because the sun evaporates the moisture at the surface, this capillary wicking action continues to draw moisture from below. The efflorescence and minerals continue to be deposited until either the salt and minerals, or the moisture supply has been exhausted.

Can the white deposits and efflorescence be removed?

Often times, mild efflorescence will weather off naturally, however in some cases a cleaner may be needed to remove the efflorescence or mineral deposits. In extreme cases these deposits may calcify and become difficult to remove, especially if they have been present for an extended period of time. If this is the case repeated applications may be required to yield the desired results.

What should I use to clean my wall?

There are many different cleaners available to remove white deposits and efflorescence, and most of our Authorized Dealers carry them. If you cannot find them locally contact The Bauer Company for information on the cleaners we have available. Regardless of the product used, it is very important to follow the application guidelines carefully to avoid damaging the concrete products.

Before:

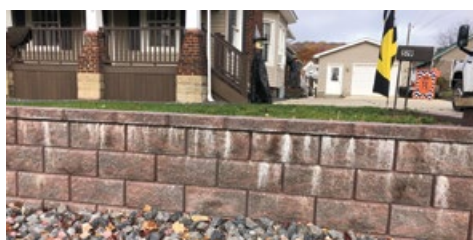

After:

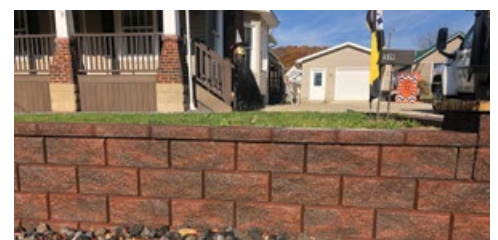

ESTIMATING

To calculate the materials required, begin by sketching out your wall including dimensions for length and height. Using a sheet of plain paper or graph paper, sketch your wall including all dimensions. Something similar to the illustration below. Also take into consideration any critical conditions that may influence your wall's geometry. You may also want to review your sketch and measurements with your local Authorized Dealer to ensure accuracy.

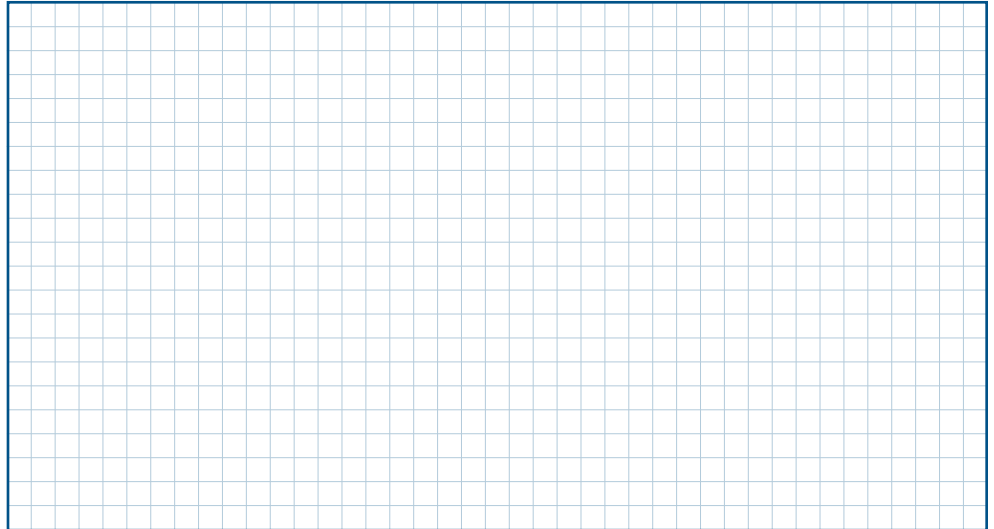

Determine your Square Feet of Face (SFF) Wall Area

To assist in estimating, sketch a bird's eye view of your project before visiting your Authorized Dealer.

Using your dimensions determine your square feet of face area by multiplying the wall length by the wall height. Remember to panelize your wall if your project has varying wall heights. Once you have a total SFF area you can estimate the total number of block you will need. The number of caps required can be determined by the overall length of the wall.

Wall Panel	Wall Length	Multiplied by	Wall Height	Equals	SFF
Panel 1		X		=	
Sidewall A		X		=	
Sidewall B		X		=	
Panel 2		X		=	
Panel 3		X		=	
TOTAL		Total Wall Length will determine quantity of cap units. Total SFF will determine quantity of stacking wall units.			
	Total Wall Length				Total SFF

Determine Your Wall Layout

If your wall height varies, divide the wall panels into segments according to height. This will assist in effectively calculating the square footage, as well as eliminate excess materials.

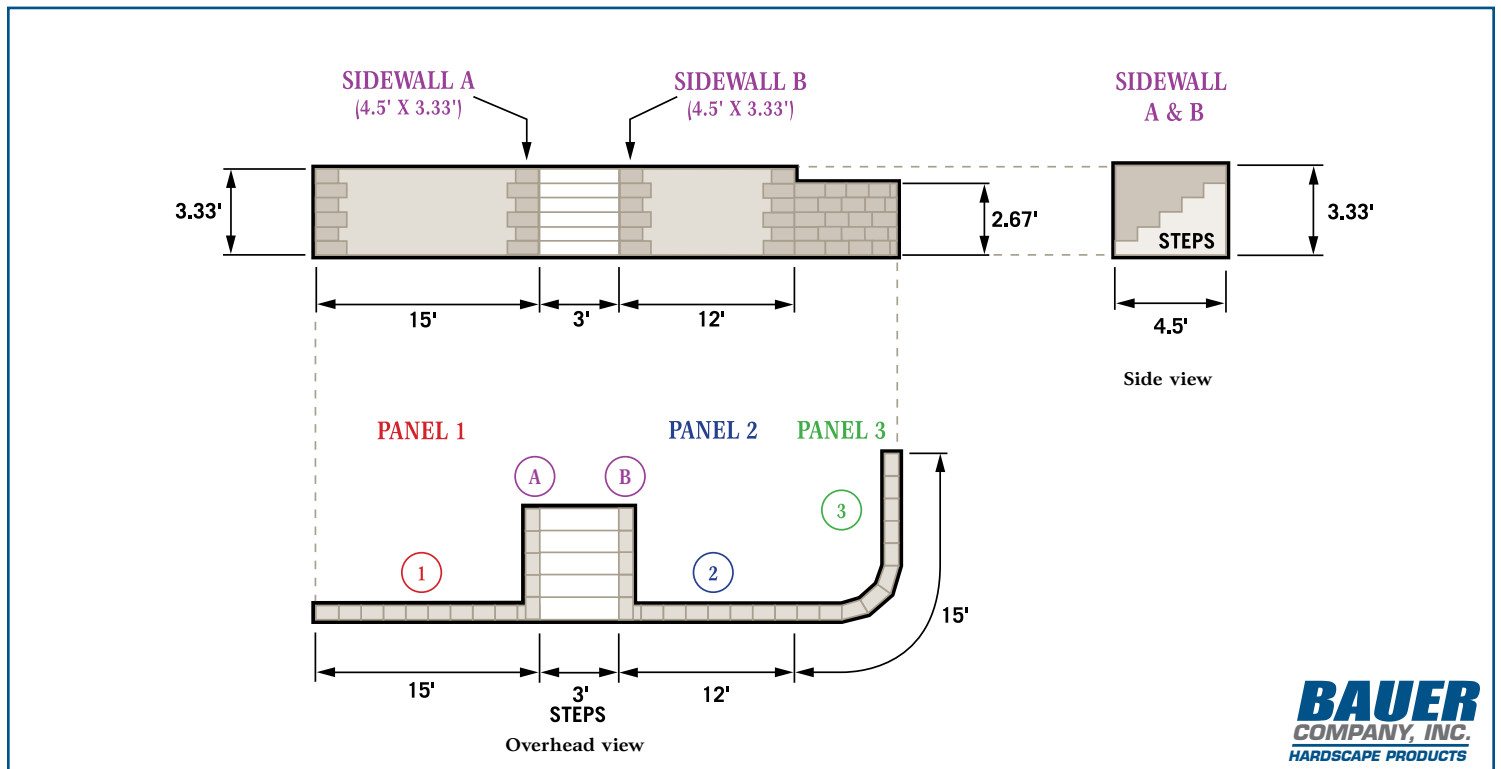



BAUER
COMPANY, INC.
HARDSCAPE PRODUCTS



The Bauer Company, Inc.
119 Ruth Hill Road • Worthington, PA 16262
Phone: 724-297-5084 • 1-800-419-WALL
Fax: 724-297-5083
email: bauerco@snydercos.com
www.bauerblock.com



Follow us on Facebook and Instagram

"The Bauer Company Inc. would like to thank all of it's Dealers, Contractors, and Customers who contributed in any way to this brochure and the continued success of our business."